

Supply Batteries

BLOCK POWER



intAct Block-Power

Sealed maintenance-free AGM battery with grid plates | electrolyte held in glass fibre mats | wet charged



intAct
BATTERY - POWER

READY FOR MANY USES

Durable, powerful series for hazard detection systems and absolutely reliable energy storage for safety power supply, safety lighting and various hobby applications. Our recommendation for all safety applications and any application to which it fits from the specifications.

- » **Quickly ready in stand-by mode.**
- » Low self-discharge.
- » Sealed block batteries with grid plates and fleece separators (AGM).
- » Absolutely maintenance-free and leak-proof.
In three versions:
- » **Block Power**
 - Medium cyclic use
 - BP12-35 **extra cyclic use**
 - **3 - 5 years design life** according to Eurobat (General Purpose)
- » **Block Power**
 - Medium cyclic use
 - BP12-50, BP12-75 **extra cycle resistant**
 - **10 to 12 years Designlife** according to Eurobat (Longlife)
- » **Block-Power SP/SPGN**
 - Extreme high current capability for short time discharge.
 - **10 to 12 years Designlife** according to Eurobat (Longlife)



Artnum.	BP6-1.2
Japan-Code	keine
Volt	6V
Capacity	1,2 AH (c20)
CCR - 18°C (EN)	
Electrolyte	diluted sulphuric acid
Electrolyte density	1,28 +/- 0,01 Kg/l (25° C)
Size (LxWxH)	97 x 24 x 57 mm
Weight	0,29 kg
Pos. of Terminal	1

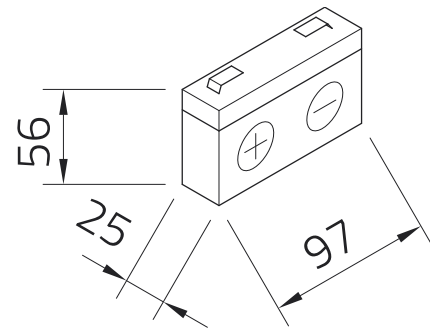
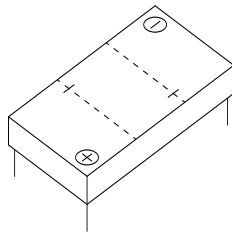

Technology Sealed maintenance-free AGM battery with grid plates | electrolyte held in glass fibre mats | wet charged

Terminal S-4,8

Base plate -

As of 17.08.2022